

# ME1 - CA

## ANALOGIC SOLENOID PUMP WITH CONSTANT FLOW RATE

### DESCRIPTION

- Analogic solenoid pump with constant flow rate
- Frequency adjustable via potentiometer
- 0-20% and 0-100% pulses setting with a single button (%)
- Easy to install and minimum maintenance required
- ON / OFF function
- Reinforced PP body
- Polycarbonate front panel
- Pump head with Manual bleed
- IP 54 Protection Degree
- Standard Power Supply 230 Vac
- 100% Made in Italy
- CE approved

### OPTIONAL

- PVDF pump head with PTFE seals (suitable to dose High Concentration Sodium Hypochlorite, or strong Oxidizing agents)
- SCHUKO plug
- ON / OFF switch

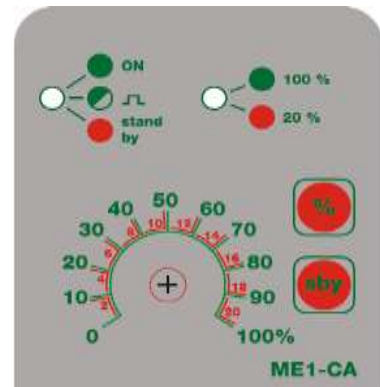

# ME1 - CA

## ANALOGIC SOLENOID PUMP WITH CONSTANT FLOW RATE

| DESCRIPTION             |                     |                          |
|-------------------------|---------------------|--------------------------|
|                         | Standard Material   | Upon request             |
| <b>Standard Version</b> |                     |                          |
| Pump Head               | PP 1/2" fitting     | PVDF 1/2" fitting        |
| Balls                   | Pyrex               | Ceramica, PTFE, AISI 316 |
| Diaphragm               | PTFE                | -----                    |
| Fittings                | PP                  | PVDF                     |
| Seals                   | Viton <sup>®</sup>  | EPDM                     |
| Valve Body              | PP 4 x 6            | PVDF 4 x 6               |
| Foot Filter             | PP 4 x 6 lip valve  | PVDF 4 x 6 ball valve    |
| Injection Valve         | PP 4 x 6 ball valve | PVDF 4x6 ball valve      |
| Suction Tube            | PVC 4 x 6           | PVDF                     |
| Delivery Tube           | PE 4 x 6            | PVDF                     |





| TECHNICAL SPECIFICATIONS |         |          |      |              |        |          |           |              |        |        |     |
|--------------------------|---------|----------|------|--------------|--------|----------|-----------|--------------|--------|--------|-----|
| Standard                 | Max l/h | Pressure |      | Max cc / imp | Stroke | Solenoid | Pump Head | Power [Watt] | Pulses | Weight |     |
|                          |         | Bar      | PSI  |              |        |          |           |              |        | kg.    | Lbs |
| 02-12                    | 02      | 12       | 174  | 0,22         | 0,9    | Ø 80     | PP        | 50           | 160    | 3,5    | 6,7 |
| 03-11                    | 03      | 11       | 160  | 0,31         | 0,9    | Ø 80     | PP        | 50           | 160    | 3,5    | 6,7 |
| 05-09                    | 05      | 09       | 131  | 0,52         | 0,9    | Ø 80     | PP        | 50           | 160    | 3,5    | 6,7 |
| 06-08                    | 06      | 08       | 116  | 0,62         | 1,1    | Ø 80     | PP        | 50           | 160    | 3,5    | 6,7 |
| 08-05                    | 08      | 05       | 72,5 | 0,83         | 1,1    | Ø 80     | PP        | 50           | 160    | 3,5    | 6,7 |
| 10-04                    | 10      | 04       | 58   | 1,04         | 1,3    | Ø 80     | PP        | 50           | 160    | 3,5    | 6,7 |
| 15-02                    | 15      | 02       | 29   | 1,56         | 1,3    | Ø 80     | PP        | 50           | 160    | 3,5    | 6,7 |
| 17-01                    | 17      | 01       | 14,5 | 1,77         | 1,3    | Ø 80     | PP        | 50           | 160    | 3,5    | 6,7 |

# ME1 - CA

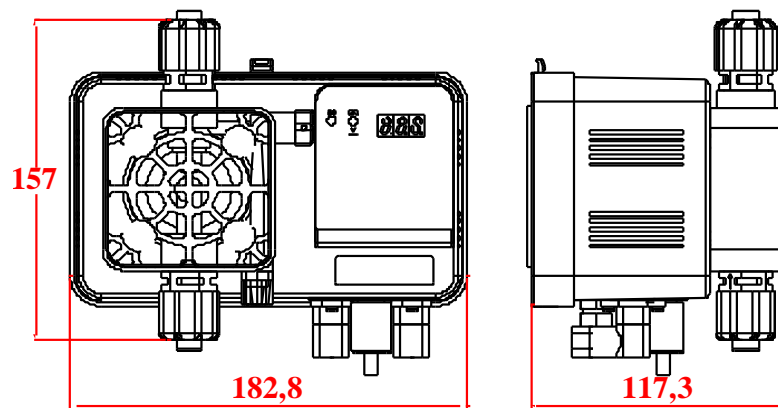
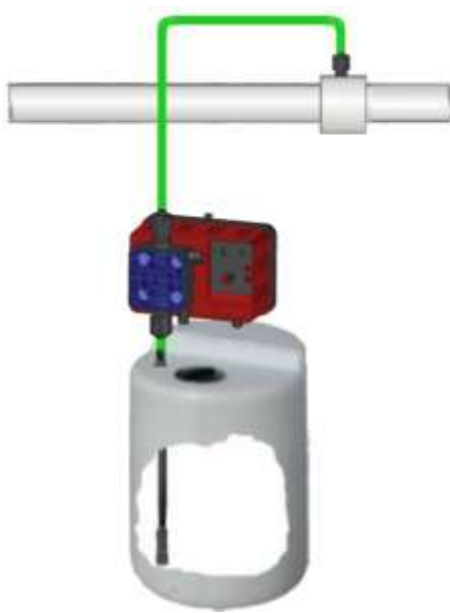
## ANALOGIC SOLENOID PUMP WITH CONSTANT FLOW RATE

### DIMENSIONI E INGOMBRI (MM)



| STANDARD KIT |   |   |   |   |   |
|--------------|---|---|---|---|---|
| STANDARD KIT | Injection Valve   | PP Foot filter with lip valve   | Delivery tube 2mt PE 4x6  | 2mt PVC 4x6 Suction tube  | 1,5mt PVC 4x6 Bleed tube  |
|              |  |  |  |  |  |